



MST
MAX SPEED TECHNOLOGY

FSX-DS

1/10 SCALE RC HIGH PERFORMANCE DRIFT CAR

EXPLODED MANUAL

ON ROAD USE ONLY
FULL BALL BEARINGS

WHEELBASE : STANDARD 257mm (adjustable)
WIDTH : STANDARD 190mm (adjustable)
GEAR RATIO : 1.89 (34T/18T)
CASTER : 12 degrees variableness
CAMBER : 0 to -12 degrees

www.rc-mst.com

※SPECIFICATION ARE SUBJECT TO CHANGE WITHOUT NOTICE

FSX-D S

1/10 SCALE RC HIGH PERFORMANCE DRIFT CAR

EXPLODED VIEW





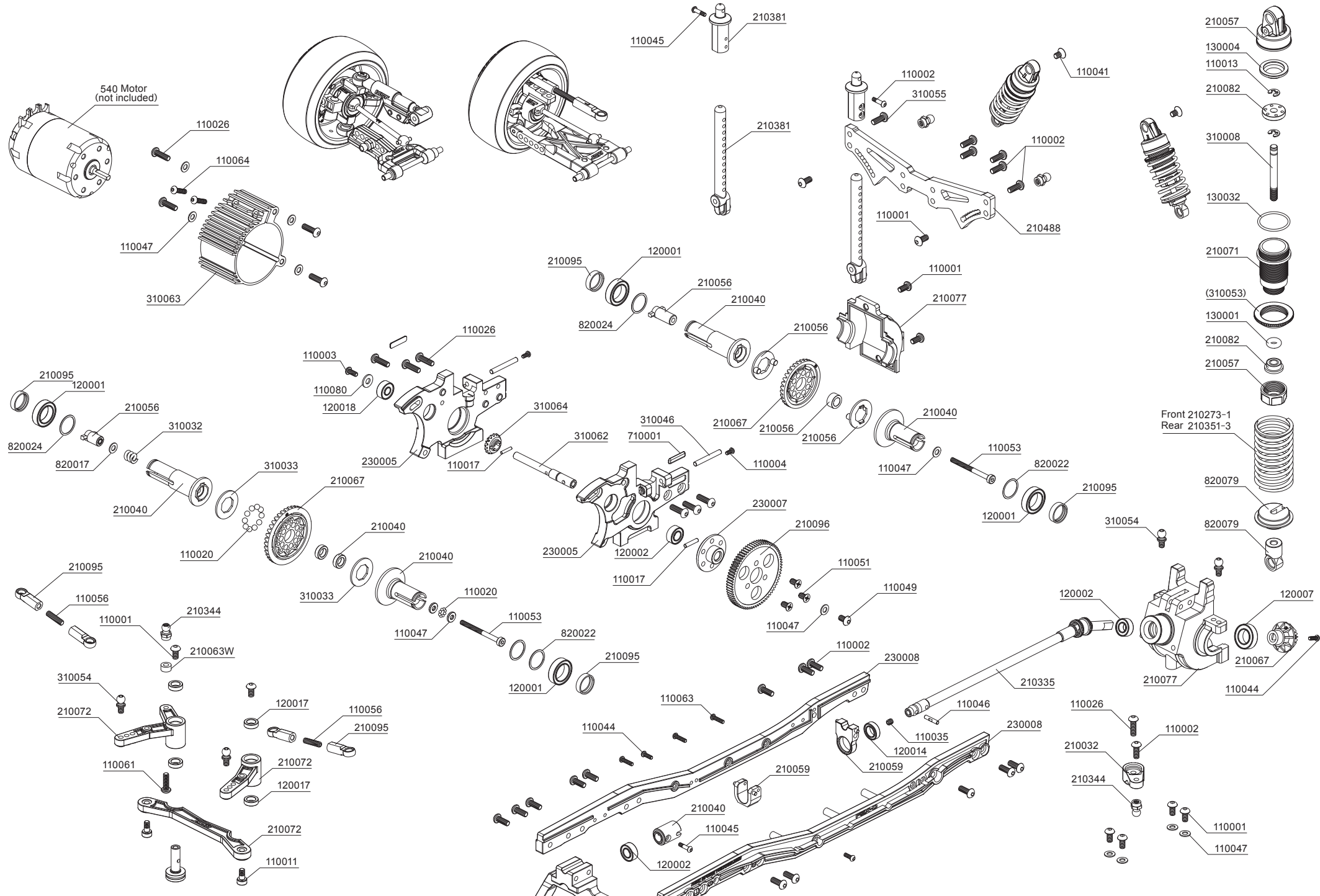

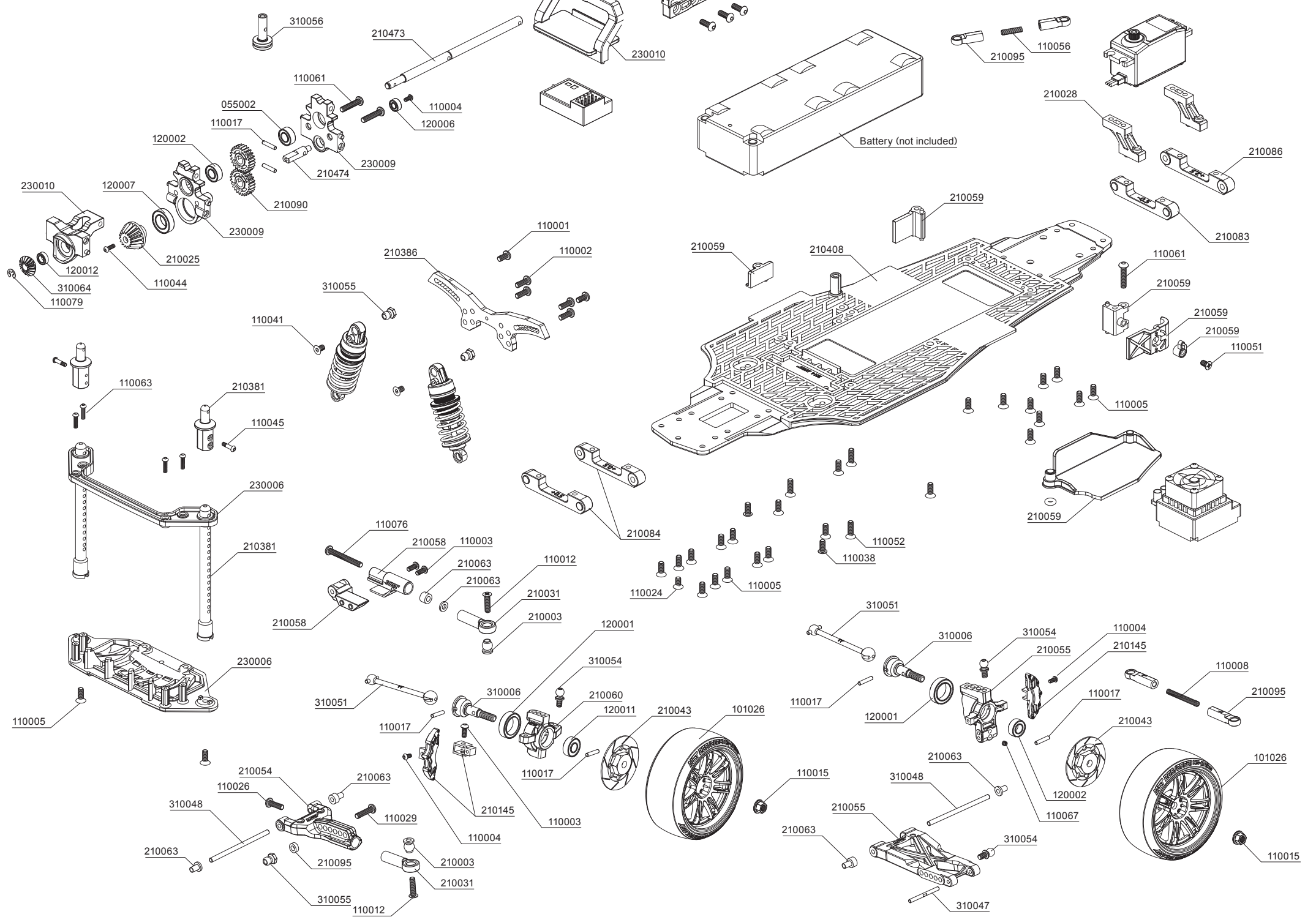





















































Please add color remark for () part number.
e.g. 210123R for Red (210123)
請增加顏色標示在 () 編號
例: 210123R for 紅色 (210123)











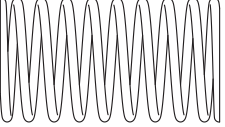
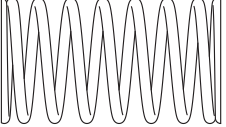
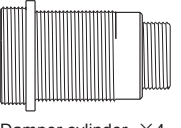

Color 顏色	Remark 標示
Red 紅	R

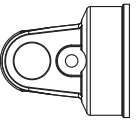



PARTS

 M2×4 Screw ×7 圓頭螺絲 110004	 M3×5 Screw ×4 十字扁頭螺絲 110051	 1.5×7.8 Shaft ×2 插銷 110059	 Steel ball 1.5 ×10 鋼珠 1.5 120008	 Steel ball 3.0 ×11 鋼珠 3.0 110020
 M2×6 Screw ×6 圓頭螺絲 110044	 M3×7 Screw ×2 十字扁頭螺絲 110038	 2×9.8 Shaft ×11 插銷 110017	 2.5×6 spacer ×2 銅板 820024	 NBR O-ring ×1 NBR O環 130023
 M2×8 Screw ×7 圓頭螺絲 110063	 M3×11 Screw ×4 十字扁頭螺絲 110012	 2×9.8 Shaft ×2 插銷(剖槽) 110046	 Diff. spring ×1 滾差彈簧 310032	 5×8×2.5 Bearing ×6 軸承 120017
 M2.5×6 Screw ×7 圓頭螺絲 110003	 M2.5×2.5 Screw ×3 止付螺絲 110067	 2.5×20 Shaft ×2 插銷 310046	 3×7 ball bearing ×1 培林 120006	
 M2.5×10 Screw ×2 圓頭螺絲 110064	 M3×3 Screw ×3 止付螺絲 110035	 2×22 Shaft ×2 插銷 310047	 4×7 ball bearing ×1 培林 120012	
 M3×5 Screw ×1 圓頭螺絲 110049	 M3×12 Screw ×3 止付螺絲 110056	 2.5×46 Shaft ×4 插銷 310048	 4×10 ball bearing ×1 培林 120018	
 M3×6 Screw ×10 圓頭螺絲 110001	 M3×25 Screw ×2 止付螺絲 110008	 Copper hex ball 4.8 ×2 銅製外六角球頭 310055	 5×10 ball bearing ×5 培林 120002	
 M3×8 Screw ×29 圓頭螺絲 110002	 M3×5 Screw ×4 沉頭螺絲 110041	 Connector nut L ×6 外六角球頭(長) 210344	 5×11 ball bearing ×4 培林 120011	
 M3×10 Screw ×13 圓頭螺絲 110026	 M3×6 Screw ×1 沉頭螺絲 110024	 Copper ball connector 4.8×4.5 ×10 銅製內六角公球頭 4.8×4.5 310054	 6×10 ball bearing ×1 培林 120014	
 M3×12 Screw ×2 圓頭螺絲 110029	 M3×8 Screw ×27 沉頭螺絲 110005	 5.8 Ball connector ×4 球頭 210003	 8×14 ball bearing ×2 培林 120007	
 M3×14 Screw ×4 圓頭螺絲 110061	 M3×10 Screw ×1 沉頭螺絲 110052	 Diff. plate ×2 滾差壓板 310033	 10×15 ball bearing ×8 培林 120001	
 M3×25 Screw ×2 圓頭螺絲 110076	 M3×6 Screw ×2 有頭螺絲 110011	 6.0 R-clip ×5 R形扣 110016	 10×12×0.1 spacer ×1 墊片 820022	
 M2×8 Screw ×5 圓頭螺絲(半牙) 110045	 M2.5×30 Screw ×2 有頭螺絲 110053	 Steel CVA universal shaft 44 ×4 鋼製CVA傳動軸44 310051	 10×12×0.3 spacer ×4 墊片 820024	
 2.6×10 Screw ×1 自攻圓頭螺絲 110025	 M4 Wheel nut ×4 輪框螺帽 110015	 2.5 E-clip ×1 E形扣 110079	 3×6×0.5 spacer ×11 墊片 110047	
 Wheel axle ×4 萬向接杯 310006		 2.6×5.8×0.6 spacer ×1 墊片 110080		

 Coil spring 29mm (hard) (silver) ×2 避震彈簧 29mm (硬) (銀) 210273-1	 Coil spring set 29mm (soft) (red) ×2 避震彈簧組 29mm (軟) (紅) 210351-3
 Damper cylinder ×4 避震筒身 210071	 Piston rod ×4 避震軸心 310008
 Spring retainer ×4 避震器調整環 310053	 Piston (black) ×4 避震活塞(黑) 210082
 Cylinder cap ×4 避震器上蓋 210057	 10.8×0.9 O-ring ×4 O環 130032
 Rod guide cap ×4 避震器下蓋 210057	 Damper O-ring ×4 避震O環 130001
 Damper retainer ×4 避震器彈簧座 820079	 E-clip ×8 E形扣 110013
	 Oil seal ×4 避震器氣室 130004
	 Rod guide (black) ×4 避震器下蓋墊片(黑) 210082
	 Damper adjuster ×4 避震器拉桿 820079

PARTS

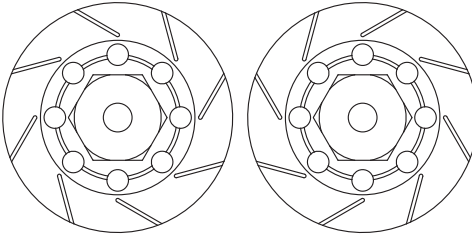
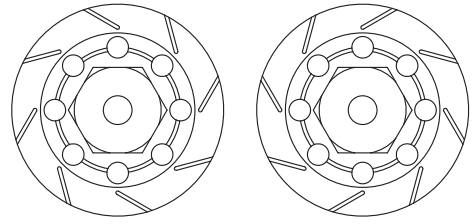

Wheel huds w/disc shape
碟型六角輪座組
210043

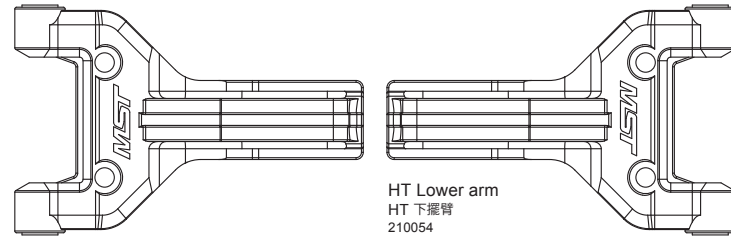

HT Lower arm
HT 下擺臂
210054

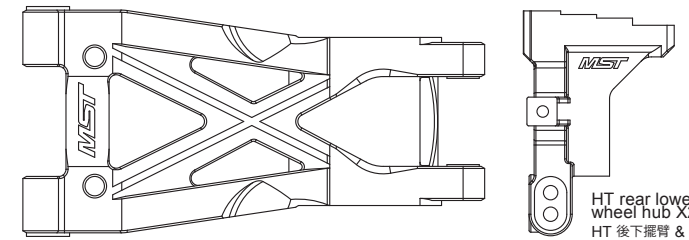

HT rear lower arm &
wheel hub X2
HT 後下擺臂 & 輪座
210055

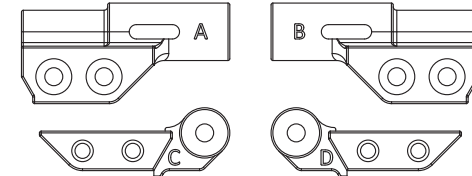

HT Upper arm
HT 上擺臂
210058

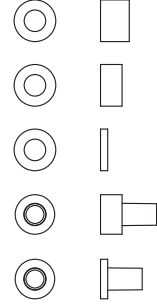

Shaft bush & spacer set
(white)
襯套墊片組(白)
210063W

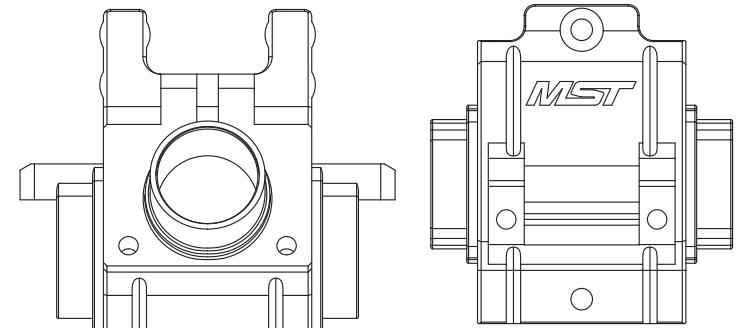

FXX Rear gear box set
FXX 後齒箱組
210077

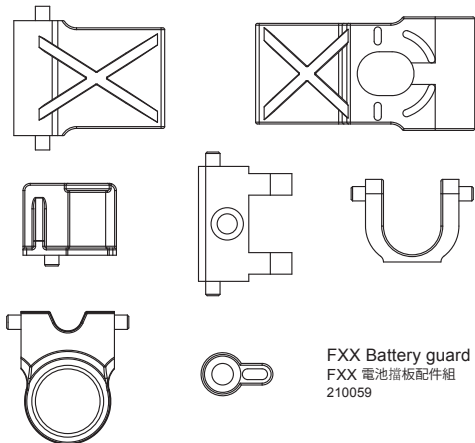
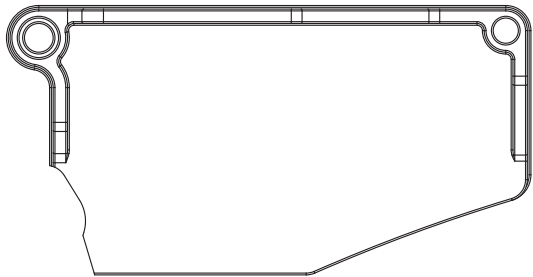

FXX Battery guard set
FXX 電池擋板配件組
210059

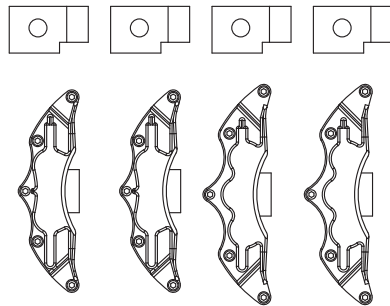

Brake calipers
剎車卡鉗
210145

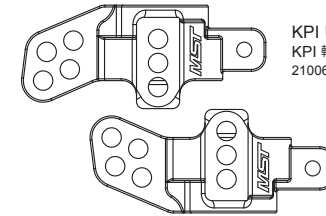

KPI Upright set
KPI 輪座組
210060

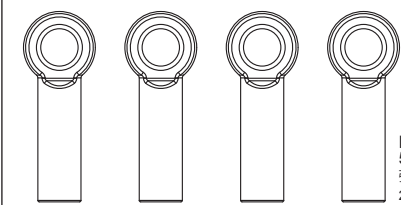

Reinforced adjuster set
5.8×26
強化拉桿頭組 5.8×26
210031

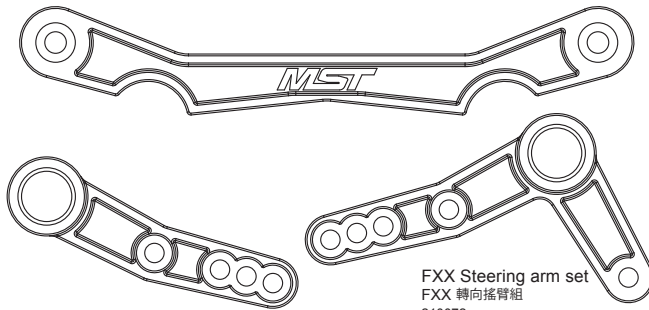

FXX Steering arm set
FXX 轉向搖臂組
210072

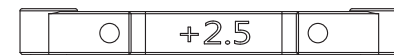

Lower arm mount +2.5 ×1
下擺臂座 +2.5
210086

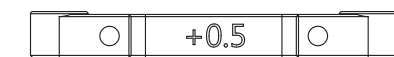

Lower arm mount +0.5 ×2
下擺臂座 +0.5
210084

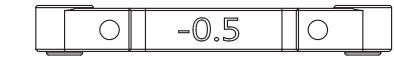

Lower arm mount -0.5 ×1
下擺臂座 -0.5
210083

PARTS

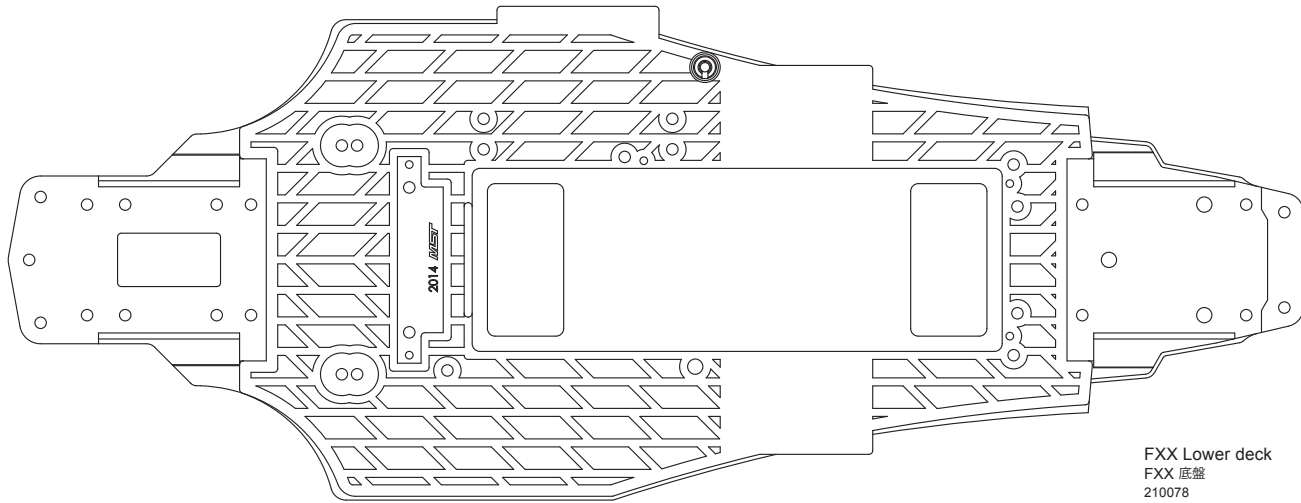

FXX Lower deck
FXX 底座
210078

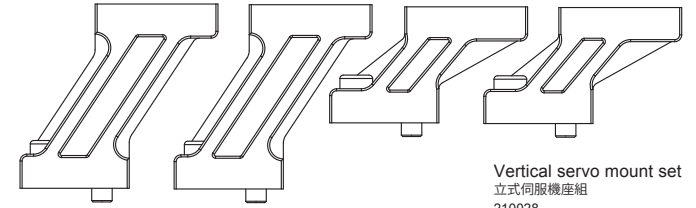

Vertical servo mount set
立式伺服機座組
210028

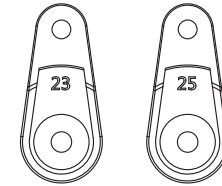

Servo horn set (23T/25T)
伺服機舵片組 (23T/25T)
210032

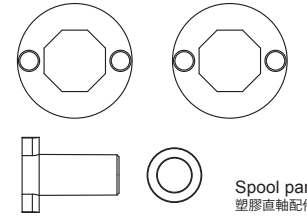

Spool parts set
塑膠直軸配件組
210056

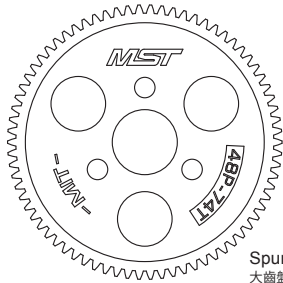

Spur gear 48P-74T
大齒盤 48P-74T
210096

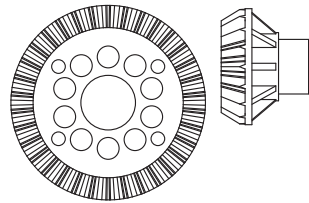

Lightweight bevel gear set 34-18
輕量化傘齒組 34-18
210069

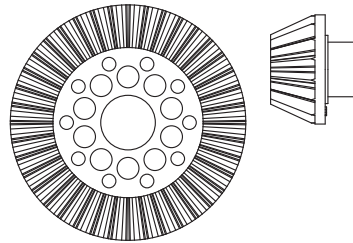

Bevel gear set 40-16
傘齒組 40-16
210025

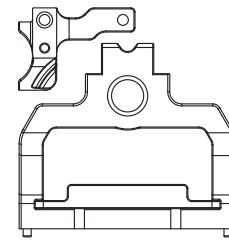

FSX Receiver holder &
bevel gear redirected mount
FSX 接收機固定座 & 換向傘齒座
230010

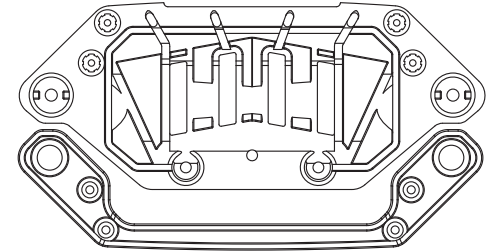

FSX Bumper set
FSX 防撞板組
230006

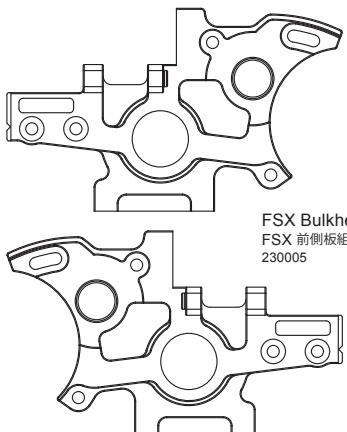

FSX Bulkhead set
FSX 前側板組
230005

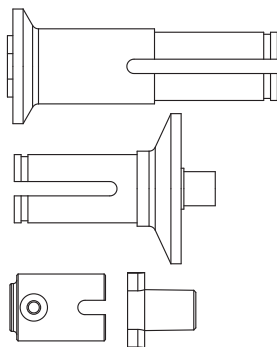

Joint set X2
接杆組
210040

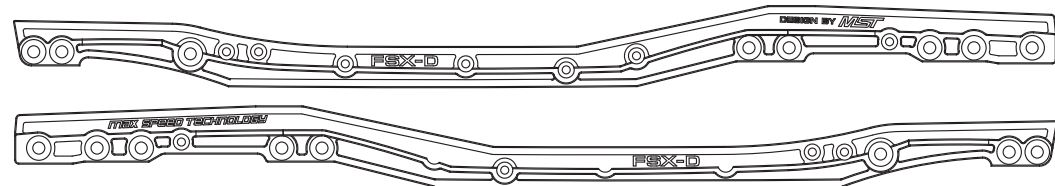

FSX Upper deck set
FSX 二樓板組
230008

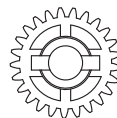

Idler gear M0.6 25T
惰輪 M0.6 25T
210090



Bevel gear M0.75x16T x4
傘齒 M0.75x16T
310064

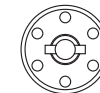

FSX Spur gear holder
FSX 大齒盤座
230007

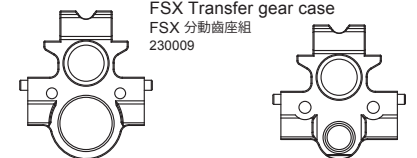

FSX Transfer gear case
FSX 分動齒座組
230009

PARTS



FSX Main shaft
FSX 主齒軸
310062

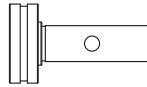

Steering arm post ×2
轉向搖臂支柱
310056

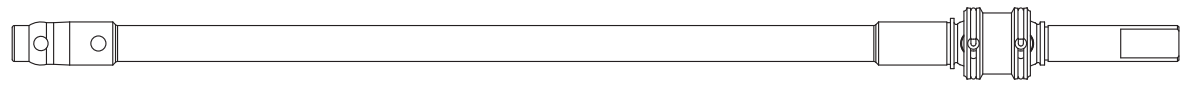

FXX Alum. rear driven shaft set
FXX 鋁合金雙節後軸組
210335



MST-PU stickers
MST-PU 貼紙
710001

FXX Carbon front damper stay 3.5
FXX 碳纖維前避震架 3.5
210386

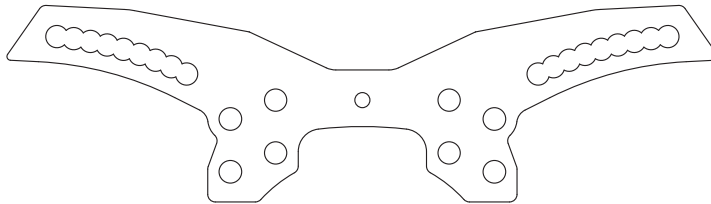

FSX Carbon rear damper stay 3.5
FSX 碳纖維後避震架 3.5
210488

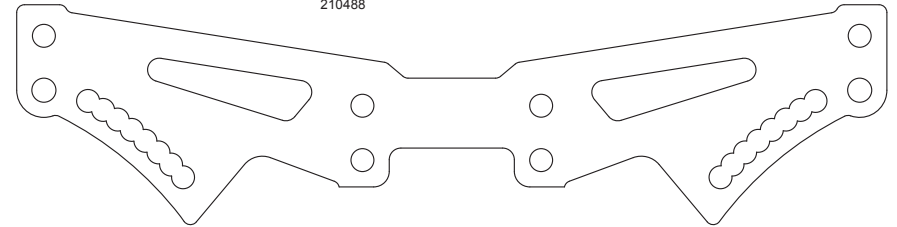

FSX Alum. drive gear shaft
FSX 鋁合金驅動齒軸
210474



CS-R tire
CS-R 甩尾胎
101026

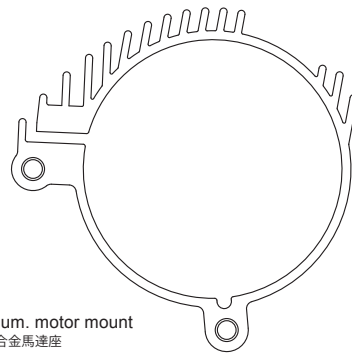

FSX Alum. motor mount
FSX 鋁合金馬達座
310063



FSX Alum. propeller shaft
FSX 鋁合金中傳軸
210473

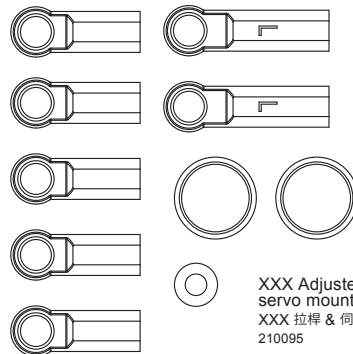

XXX Adjuster &
servo mount set X2
XXX 拉桿 & 伺服機座
210095

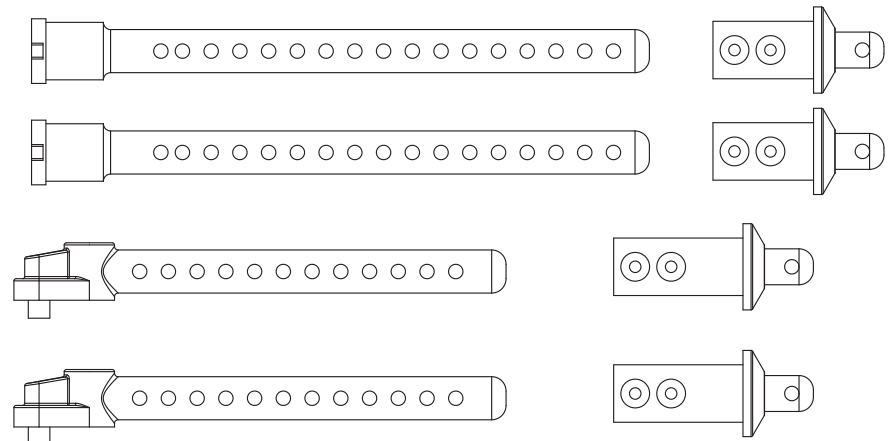

Car body post set
車殼支柱組
210381

PARTS CODE

101026	CS-R tire (hard) (4)	110049	Round head screw M3X5 (10)	130006	Double sided tape(5)	210072	FXX Steering arm set	310046	Arm shaft 2.5X20 (2)
110001	Round head screw M3X6 (10)	110051	Flat head screw M3X5 (5)	130008	Black grease	210077	FXX Rear gear box set	310047	Arm shaft 2.0X22 (2)
110002	Round head screw M3X8 (10)	110052	Countersunk screw M3X10 (10)	130009	Damper oil #300	210082	Piston spacer set	310048	Arm shaft 2.5X46 (4)
110003	Round head screw M2.5X6 (6)	110053	Cap screw M2.5X30 (2)	130017	Inner sponge (8)	210083	Lower arm mount -0.5	310051	CVA Swing shaft 44 (2)
110004	Round head screw M2X4 (6)	110056	Set screw M3X12 (6)	130021	Sponge 6.5X2 (10)	210084	Lower arm mount +0.5	310054	Copper ball connector 4.8X4.5 (4)
110005	Countersunk screw M3X8 (10)	110059	Shaft 1.5X7.8 (8)	130023	O-ring P3 (black) (10)	210086	Lower arm mount +2.5	310055	Copper hex ball 4.8 (4)
110008	Set screw M3X25 (6)	110061	Round head screw M3X14 (6)	130032	Damper cap O-ring (10)	210090	Idler gear M0.6 25T (2)	310056	FXX Steering arm post
110011	Cap screw M3X6 (6)	110063	Round head screw M2X8 (6)	130034	Sponge 20X80X1 (4)	210095	XXX Adjuster & servo mount set	310062	FSX Main shaft
110012	Flat head screw M3X11 (10)	110064	Round head screw M2.5X10 (6)	130035	L Wrench set (1.5&2.0&2.5)	210096	Spur gear 48P-74T	310064	Bevel gear 16T (2)
110013	E-clip 2.0 (10)	110067	Set screw M2.5X2.5 (6)	130040	Ball diff. grease	210145	Brake calipers (4)	710001	MST-PU Sticker (4)
110015	Flange nut M4 (4)	110076	Round head screw M3X25 (6)	210003	D PARTS-ball connector	210344	Ball connector nut L 4.8 (4)	820022	Spacer 10X12X0.1 (8)
110016	R-clip 6.0 (10)	110079	E-clip 2.5 (10)	210025	Bevel gear set 40-16	210381	Car body post set	820024	Spacer 10X12X0.3 (8)
110017	Shaft 2X9.8 (10)	110080	Spacer 2.6X5.8X0.6 (8)	210028	Vertical servo mount set	210386	FXX Carbon front damper stay 3.5	820079	Damper plastic maintenance set (2)
110020	Steel ball 3.0 (13)	120001	Ball bearing 10X15 (4)	210031	Reinforced adjuster set 5.8X26	210408	FXX-D S Strengthen lower deck	210063W	Shaft bush & spacer set (white)
110024	Countersunk screw M3X6 (10)	120002	Ball bearing 5X10 (4)	210032	Servo horn set (23T/25T)	210488	FSX Carbon rear damper stay 3.5	210067W	Arm shaft bush 2.0 (white) (4)
110025	Tapping round head screw 2.6X10 (6)	120006	Ball bearing 3X7 (2)	210040	Joint set	230005	FSX Bulkhead set	210273-1	Coil spring 29mm (hard) (silver) (2)
110026	Round head screw M3X10 (10)	120007	Ball bearing 8X14 (2)	210043	Wheel hubs w/disc shape	230006	FSX Bumper set	210335R	FXX Alum. rear drive shaft set (red)
110029	Round head screw M3X12 (6)	120008	Thrust bearing 2.5X6	210054	HT Lower arm	230007	FSX Spur gear holder	210351-3	Coil spring set 29mm (soft) (red) (2)
110035	Set screw M3X3 (6)	120011	Ball bearing 5X11 (4)	210055	HT Rear lower arm & wheel hub	230008	FSX Upper deck set	210473R	FSX Alum. propeller shaft (red)
110038	Flat head screw M3X7 (10)	120012	Ball bearing 4X7 (2)	210056	Spool parts set	230009	FSX Transfer gear case	210474BK	FSX Alum. drive gear shaft (black)
110041	Countersunk screw M3X5 (10)	120014	Ball bearing 6X10X3 (2)	210057	Damper cap set	230010	FSX Receiver holder & bevel gear redirected mount	310053R	Spring retainer (red) (2)
110044	Round head screw M2X6 (6)	120017	Bearing 5X8 (4)	210058	HT Upper arm	310006	Wheel axle (2)	310063R	FSX Alum. motor mount (red)
110045	Round head screw M2X8 (partial thread) (6)	120018	Bearing 4X10X4 (2)	210059	FXX Battery guard set	310008	Piston rod (4)	700003S	5.5 & 7.0 Alum. wrench (silver)
110046	Shaft 2X9.8 (8)	130001	Damper O-ring P3 (red) (10)	210060	KPI Upright set	310032	Diff. screw & spring set		
110047	Spacer 3X6X0.5 (8)	130004	Oil seal (4)	210071	Damper cylinder (2)	310033	Diff. plate (2)		

OPTION PARTS CODE

210143	Alum. wheel hubs 6mm (brake disc shaped)	210266	Coil spring set 25mm (8)	210375	FXX Rear stabilizer set	210475BK	FSX Alum. quick-release drive gear shaft (black)	820050R	Alum. damper retainer (red) (4)
210145FGD	Brake calipers (flat gold) (4)	210273	Coil spring set 29mm (8)	210379	Rear bumper	820039R	Alum. suspension mount (+2.5) (red)	820052	Wheel weighting ring (2)
210145FS	Brake calipers (flat silver) (4)	210282	MST Diffuser	210384R	FXX Alum. rear gear box (red)	820040	MST Balancing weights 10g	820057R	Adjustable alum. suspension mount (-0.5+1.0) (red)
210145P	Brake calipers (anodized purple) (4)	210336R	FXX Alum. steering arm set (red)	210388	FXX Carbon steering joint plate 2.5	820041	MST Balancing weights 30g	820058R	Adjustable alum. suspension mount (+1.5+3.0) (red)
210145R	Brake calipers (anodized red) (4)	210341R	FXX Alum. bearing holder (red)	210389	FXX Carbon lower deck 2.5	820048R	Wheel hub spacer 0.5 (red) (4)	820059	Suspension mount spacer 0.2mm (10)
210205	DK Coil spring set 30mm	210365R	FXX Reinforced propeller shaft set (red)	210439	MST Rear balancing diffuser	820049R	Wheel hub spacer 1.0 (red) (4)	841002	LSD 2.0 RS Gyro

部品編號

101026	CS-R尾尾胎 (硬) (4)	110049	六角半圓頭螺絲 M3X5 (10)	130006	泡棉雙面膠 (5)	210072	FXX 轉向搖臂組	310046	擺臂插銷 2.5X20 (2)
110001	六角半圓頭螺絲 M3X6 (10)	110051	十字扁頭螺絲 M3X5 (5)	130008	黑色油膏	210077	FXX 後齒箱組	310047	擺臂插銷 2.0X22 (2)
110002	六角半圓頭螺絲 M3X8 (10)	110052	六角沉頭螺絲 M3X10 (10)	130009	避震油 #300	210082	避震器活塞墊片組	310048	擺臂插銷 2.5X46 (4)
110003	六角半圓頭螺絲 M2.5X6 (6)	110053	六角有頭螺絲 M2.5X30 (半牙) (2)	130017	吸震泡棉 (8)	210083	下擺臂座 -0.5	310051	CVA傳動軸 44 (2)
110004	六角半圓頭螺絲 M2X4 (6)	110056	六角止付螺絲 M3X12 (6)	130021	泡棉 6.5X2 (10)	210084	下擺臂座 +0.5	310054	鋼製內六角球頭 4.8X4.5 (4)
110005	六角沉頭螺絲 M3X8 (10)	110059	插銷 1.5X7.8 (8)	130023	O環 P3 (黑) (10)	210086	下擺臂座 +2.5	310055	鋼製外六角球頭 4.8 (4)
110008	六角止付螺絲 M3X25 (6)	110061	六角半圓頭螺絲 M3X14 (6)	130032	避震上蓋 O環 (10)	210090	惰輪 M0.6 25T (2)	310056	FXX 轉向搖臂支柱
110011	六角有頭螺絲 M3X6 (半牙) (6)	110063	六角半圓頭螺絲 M2X8 (6)	130034	吸震泡棉 20X80X1 (4)	210095	XXX 拉桿 & 伺服機座	310062	FSX 主齒輪
110012	十字扁頭螺絲 M3X11 (10)	110064	六角圓頭螺絲 M2.5X10 (6)	130035	L板手組 (1.5&2.0&2.5)	210096	大齒盤 48P-74T	310064	傘齒16T (2)
110013	E扣 2.0 (10)	110067	六角止付螺絲 M2.5X2.5 (6)	130040	滾珠差速油	210145	煞車卡鉗 (4)	710001	MST-PU貼紙 (4)
110015	凸緣螺帽 M4 (4)	110076	六角半圓頭螺絲 M3X25 (6)	210003	D PARTS	210344	球頭螺帽L 4.8 (4)	820022	墊片 10X12X0.1 (8)
110016	R銷 6.0 (10)	110079	E扣 2.5 (10)	210025	傘齒組 40-16	210381	車殼支柱組	820024	墊片 10X12X0.3 (8)
110017	插銷 2X9.8 (10)	110080	墊片 2.6X5.8X0.6 (8)	210028	立式伺服機座組	210386	FXX 碳纖維前避震架 3.5	820079	避震器零件包 (2)
110020	差速鋼珠 3.0 (13)	120001	培林 10X15 (4)	210031	強化拉桿頭組 5.8X26	210408	FXX-D S 強化底盤	210063W	襯套墊片組 (白)
110024	六角沉頭螺絲 M3X6 (10)	120002	培林 5X10 (4)	210032	伺服機舵片組 (23T/25T)	210488	FSX 碳纖維後避震架 3.5	210067W	擺臂插銷襯套2.0 (白) (4)
110025	自攻六角半圓頭螺絲 2.6X10 (6)	120006	培林 3X7 (2)	210040	接杯組	230005	FSX 前側板組	210273-1	避震彈簧 29mm (硬) (銀) (2)
110026	六角半圓頭螺絲 M3X10 (10)	120007	培林 8X14 (2)	210043	碟型六角輪座組	230006	FSX 防撞板組	210335R	FXX 鋁合金雙節後軸組 (紅)
110029	六角半圓頭螺絲 M3X12 (6)	120008	止推培林 2.5X6	210054	HT 下擺臂	230007	FSX 大齒盤座	210351-3	避震彈簧組 29mm (軟) (紅) (2)
110035	六角止付螺絲 M3X3 (6)	120011	培林 5X11 (4)	210055	HT 後下擺臂&輪座	230008	FSX 二樓板組	210473R	FSX 鋁合金中傳軸 (紅)
110038	十字扁頭螺絲 M3X7 (10)	120012	培林 4X7 (2)	210056	塑膠直軸配件組	230009	FSX 分動齒座組	210474BK	FSX 鋁合金驅動齒輪 (黑)
110041	六角沉頭螺絲 M3X5 (10)	120014	培林 6X10X3 (2)	210057	避震器上下蓋組	230010	FSX 接收機固定座 & 換向傘齒座	310053R	避震器調整環 (紅) (2)
110044	六角半圓頭螺絲 M2X6 (6)	120017	軸承 5X8 (4)	210058	HT 上擺臂	310006	萬向接杯 (2)	310063R	FSX 鋁合金馬達座 (銀)
110045	六角半圓頭螺絲 M2X8 (半牙) (6)	120018	培林 4X10X4 (2)	210059	FXX電池擋板配件組	310008	避震軸心 (4)	700003S	5.5 & 7.0 鋁合金套筒工具 (銀)
110046	插銷 2X9.8 (剖溝) (8)	130001	阻尼器 O環 P3 (紅) (10)	210060	KPI 輪座組	310032	滾差彈簧螺絲組		
110047	墊片 3X6X0.5 (8)	130004	避震氣室 (4)	210071	避震器筒身 (2)	310033	滾差壓板 (2)		

改裝品編號

210143	鋁合金六角輪座 6mm (煞車碟型)	210266	避震彈簧組 25mm (8)	210375	FXX 後防傾桿組	210475BK	FSX 鋁合金驅動齒輪 (快拆) (黑)	820050R	鋁合金彈簧座 (紅) (4)
210145FGD	煞車卡鉗 (消光金) (4)	210273	避震彈簧組 29mm (8)	210379	後防撞板	820039R	鋁合金擺臂座 (+2.5) (紅)	820052	輪框加重環 (2)
210145FS	煞車卡鉗 (消光銀) (4)	210282	MST 後擾流板	210384R	FXX 鋁合金後齒箱 (紅)	820040	MST 配重塊 10g	820057R	可調式鋁合金擺臂座 (-0.5+1.0) (紅)
210145P	煞車卡鉗 (電鍍紫) (4)	210336R	FXX 鋁合金轉向搖臂組 (紅)	210388	FXX 碳纖維轉向連接板 2.5	820041	MST 配重塊 30g	820058R	可調式鋁合金擺臂座 (+1.5+3.0) (紅)
210145R	煞車卡鉗 (電鍍紅) (4)	210341R	FXX 鋁合金二樓板培林架 (紅)	210389	FXX 碳纖維底盤 2.5	820048R	輪座墊片 0.5 (紅) (4)	820059	擺臂座墊片 0.2mm (銀)
210205	DK避震彈簧組 30mm	210365R	FXX 強化雙節後軸組 (紅)	210439	MST 後下配重擾流板	820049R	輪座墊片 1.0 (紅) (4)	841002	LSD 2.0 RS 陀碟環

Color 顏色	Remark 標示
Red 紅	R